

ASSEMBLY INSTRUCTION

Lifestyle

FURNITURE

www.lifestylefurniture.co.uk

15MINS

APPOXIMATE ASSEMBLY TIME

2 PERSONS ASSEMBLY

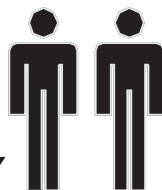

FLOOR AREA
2M X 2.5M



REQUIRED ASSEMBLY SPACE

REQUIRED ASSEMBLY TOOLS

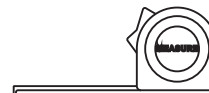

ASSEMBLED DIMENSIONS

125x45x50 cm

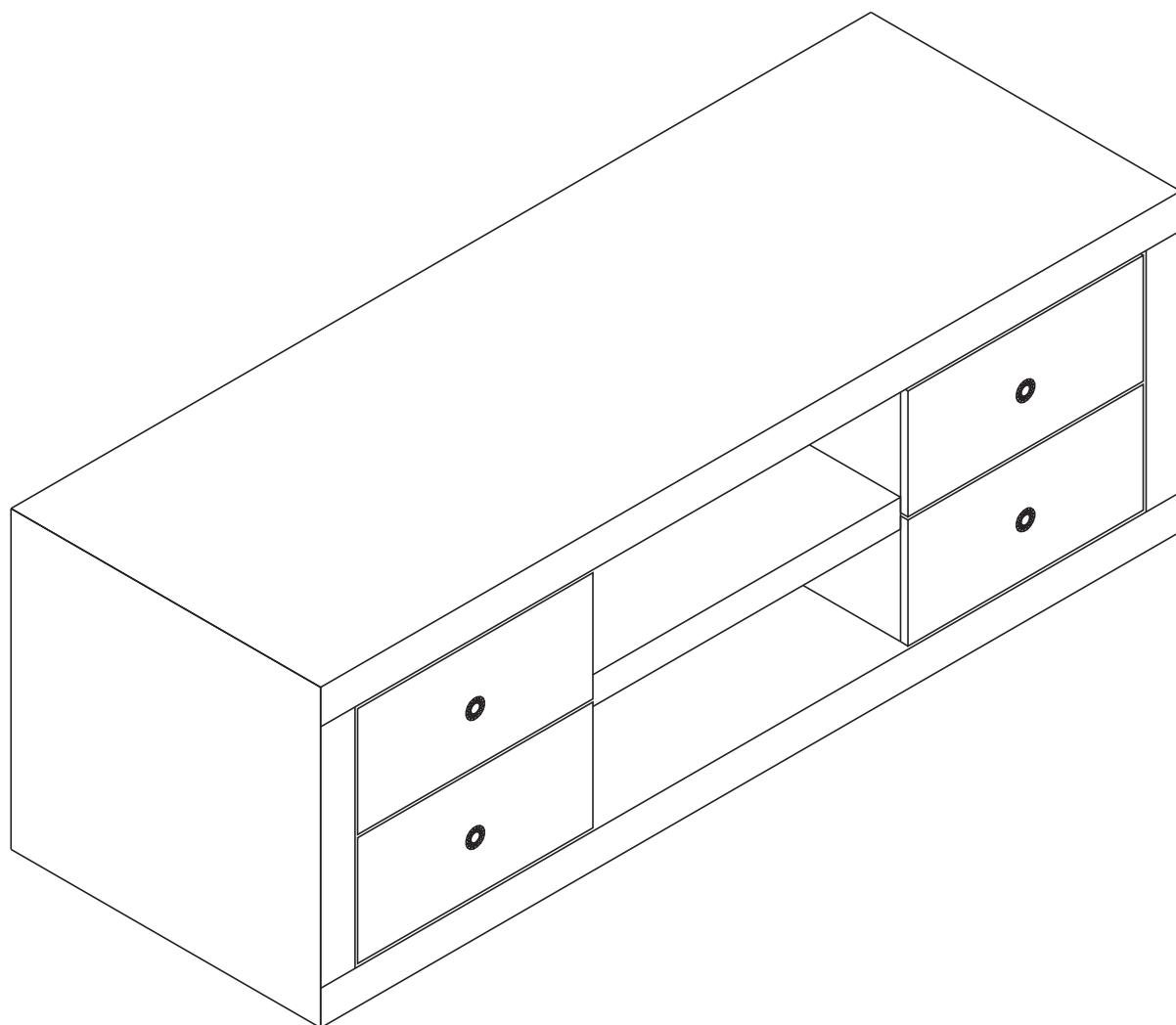



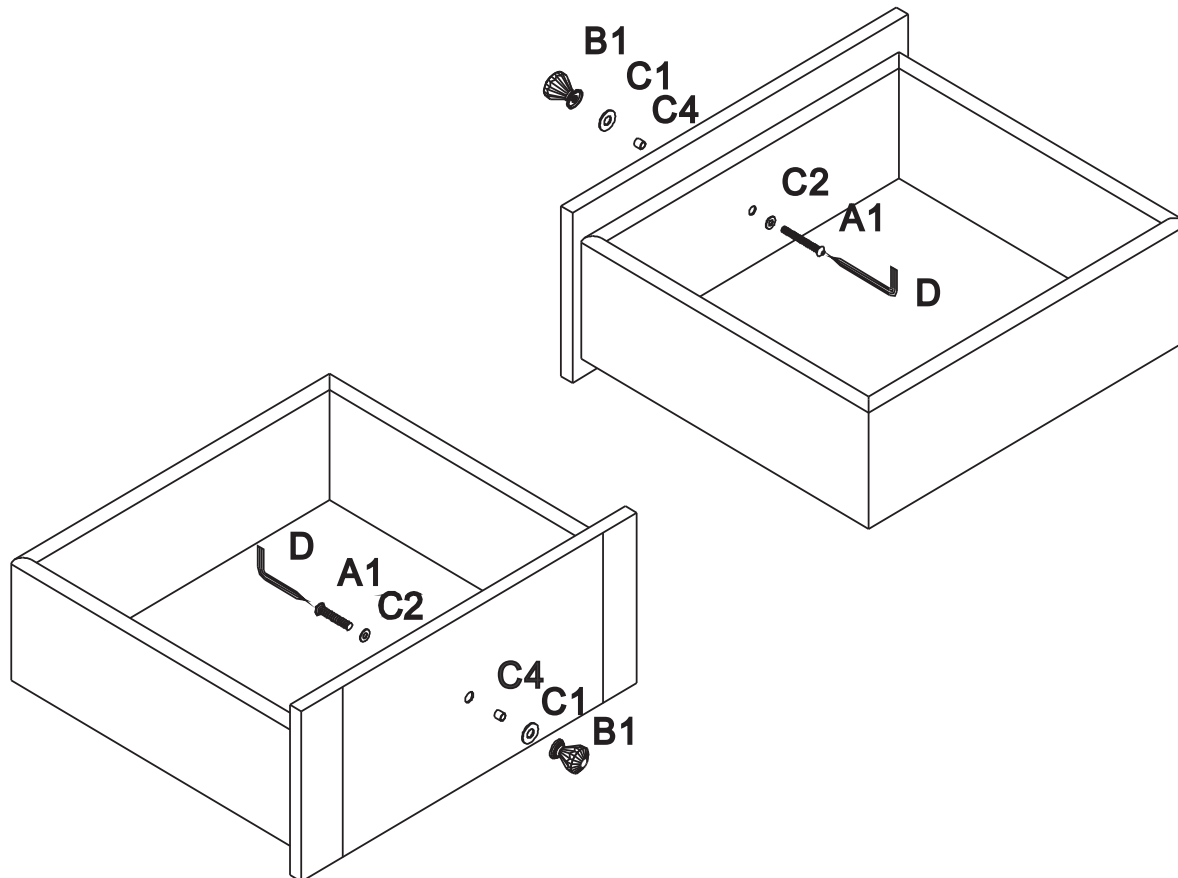

DRAWER LIST

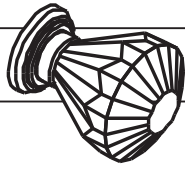

Warning: Please do not over tighten the handle

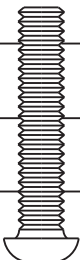
HARDWARE LIST

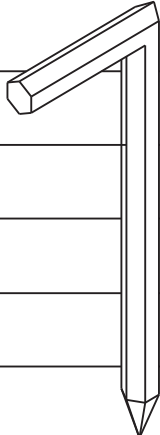
						7cm
						6cm
						5cm
						4cm
						3cm
						2cm
						1cm
						0cm
						
4X M3.5 C2 Metal washer	4X B1 Handle	4X C4 Ring	4X M3.5X35mm A1 Bolt	4X M3.5 C1 Rubber washer	1X 8MM D Allen Key	

Top Tips before you start !

1. Please check that all parts are present before you start the assembly of your furniture, as once assembled, the furniture is exempt from our home approval policy.
2. For ease and speed of assembly, we recommend that before you commence each step of the assembly, that you identify all the parts required for that step.
3. For larger items, please ensure that you have sufficient space and people (as indicated on page 1) to assemble your product safely.
4. We recommend that, where possible, all items are assembled near to the area in which they will be placed in use, to avoid moving the product unnecessarily once assembled.
5. For the protection of your furniture, particularly items of high gloss finish, we recommend that the product is placed on a protected surface during assembly to prevent any damage.
6. During assembly please take care not to over-tighten any fittings, as this may damage the product.

Care and Maintenance of your furniture.

- Please periodically check all fittings and re-tighten as necessary.
- Please do not drag or pull your furniture.
- Wipe occasionally with a soft cloth slightly dampened with water, then buff with a dry clean soft cloth.
- Never allow any kind of liquid to remain on your furniture. Absorption can cause wood to warp or finishes to de-laminate.
- Please do not place hot item (e.g. hot drinks) directly on to the wood surface.
- If the glass is chipped or broken, stop using the product and consult the supplier.
- Please do not place very hot or very cold items on the glass surface, unless adequately thick table mats are used to prevent such items from coming into contact with the glass.
- Please do not use glass as chopping surface. Do not strike the glass with hard or pointed items.
- When cleaning glass panels use a damp cloth with washing up liquid or soft soap if necessary. Do not use washing powders or any other substances containing abrasives since these substances scratch glass panel.

FITTING OF ANTI-TIP STRAP

STEP 1:

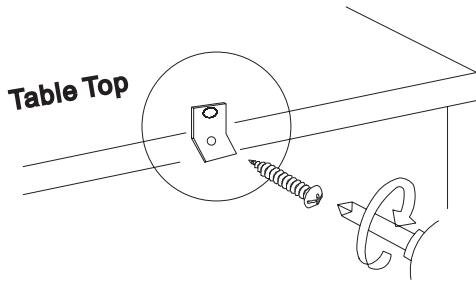

STEP 2:

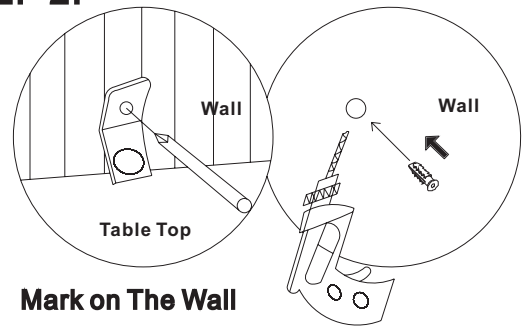

Mark on The Wall

Drill a hole in the wall and insert the rawl plug.

STEP 3:

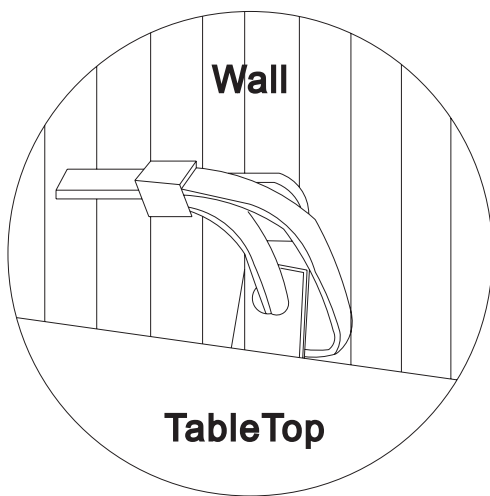

HARDWARE LIST



Anti-Tip Strap

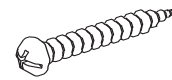

The screw supplied is to fix the strap to the table.

Note: Wall fixings are not supplied with this product as different wall materials require different types of fixing devices (such as Rawl plugs on brick work). You must use fixing devices suitable for the type of wall you intend to mount this product to. Please ensure that the head of any screw used has diameter greater than the diameter of the mounting hole on the bracket and that the fixing is safe and secure before use. The screw supplied is to fix the bracket to the table.

Wall Types:

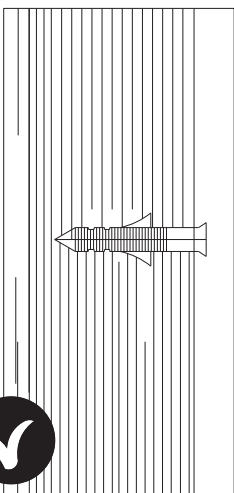

Wood
(Can use rawl plug as shown)

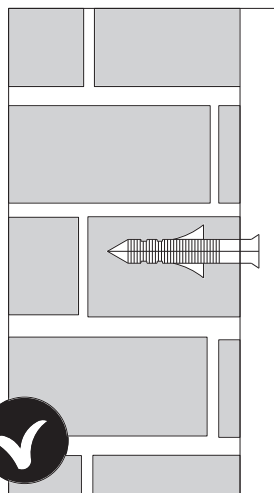

Brick & Masonry
(Can use rawl plug as shown)

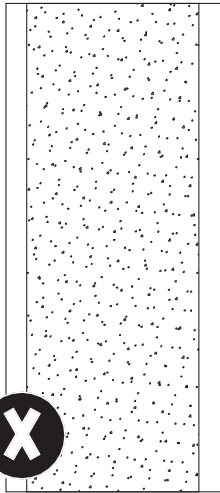

Chipboard
(Can't use any type of wall plugs)

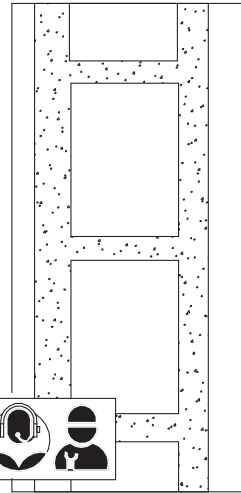

Cavity Wall
(Special toggle wall plugs are needed, Seek expert advice)

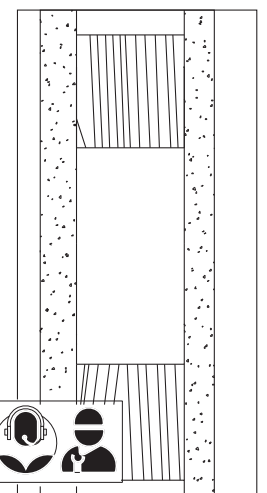

Stud Partition/Plaster
(Special toggle wall plugs are needed, Seek expert advice)