

# ASSEMBLY INSTRUCTION

# Lifestyle

FURNITURE

[www.lifestylefurniture.co.uk](http://www.lifestylefurniture.co.uk)

## 15MINS

APPOXIMATE ASSEMBLY TIME



2 PERSONS ASSEMBLY

FLOOR AREA  
2M X 2.5M



REQUIRED ASSEMBLY SPACE

REQUIRED ASSEMBLY TOOLS

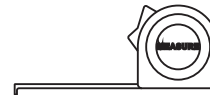

ASSEMBLED DIMENSIONS

70x25x83 cm

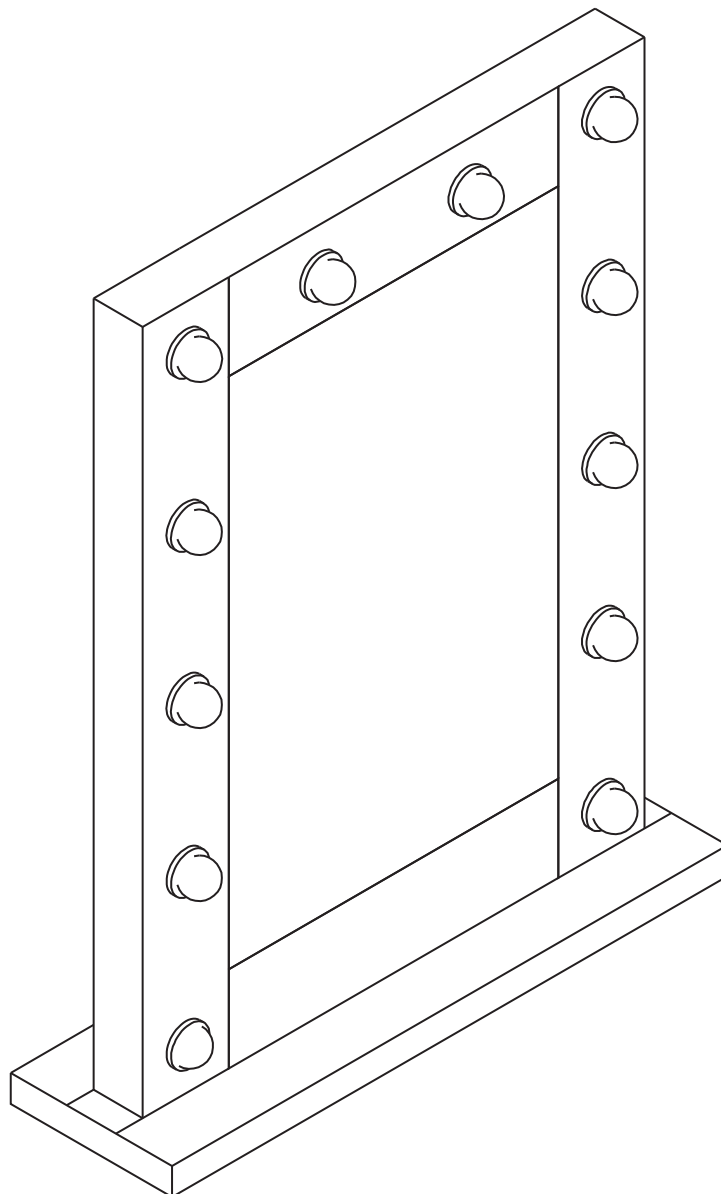

## PART LIST

## NO. PARTS LIST QTY

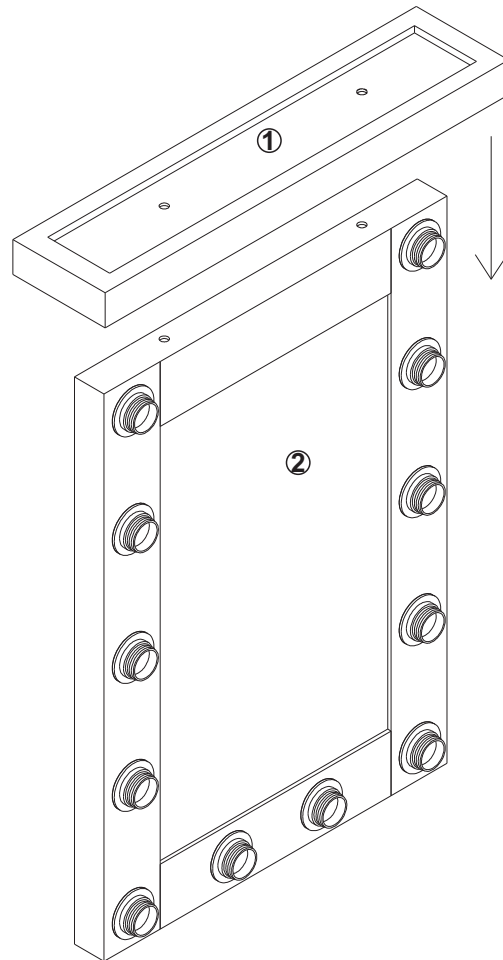

- ① Base 1pc
- ② Mirror 1pc

## HARDWARE LIST

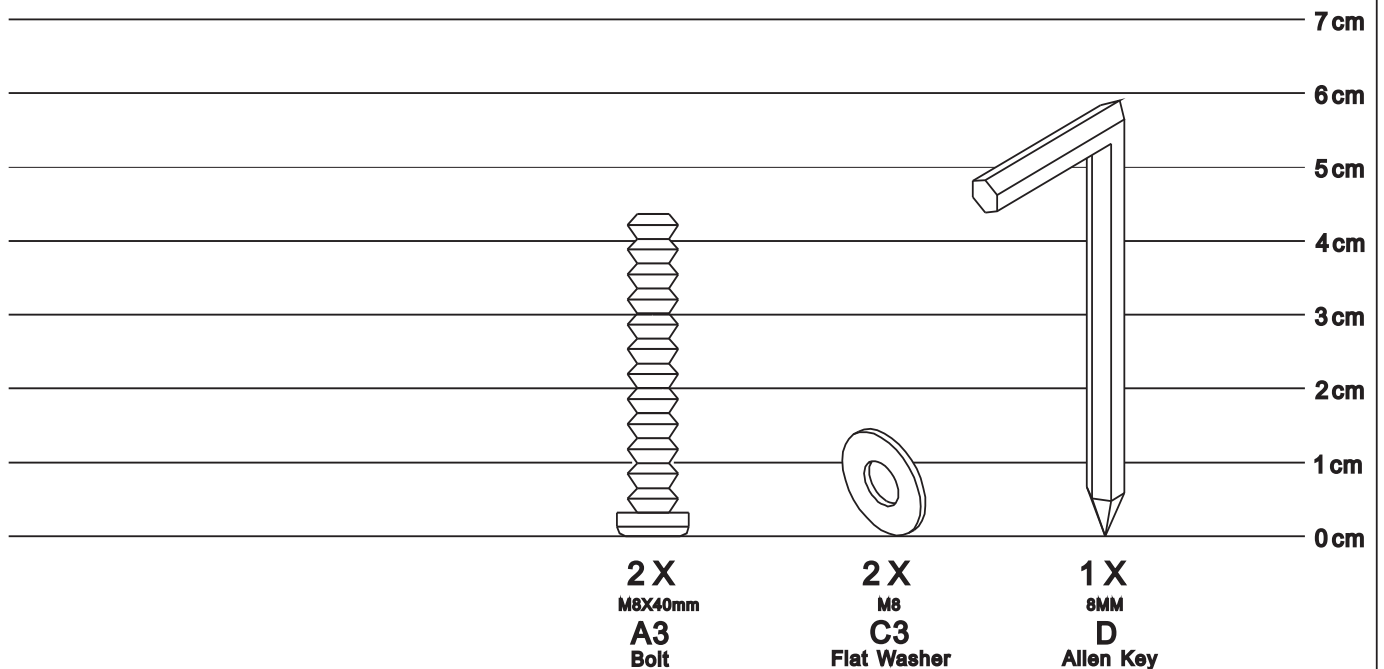

# ASSEMBLY INSTRUCTION

# Lifestyle

FURNITURE

[www.lifestylefurniture.co.uk](http://www.lifestylefurniture.co.uk)

Assemble according to the drawing, use the allen key to turn the screw clockwise.

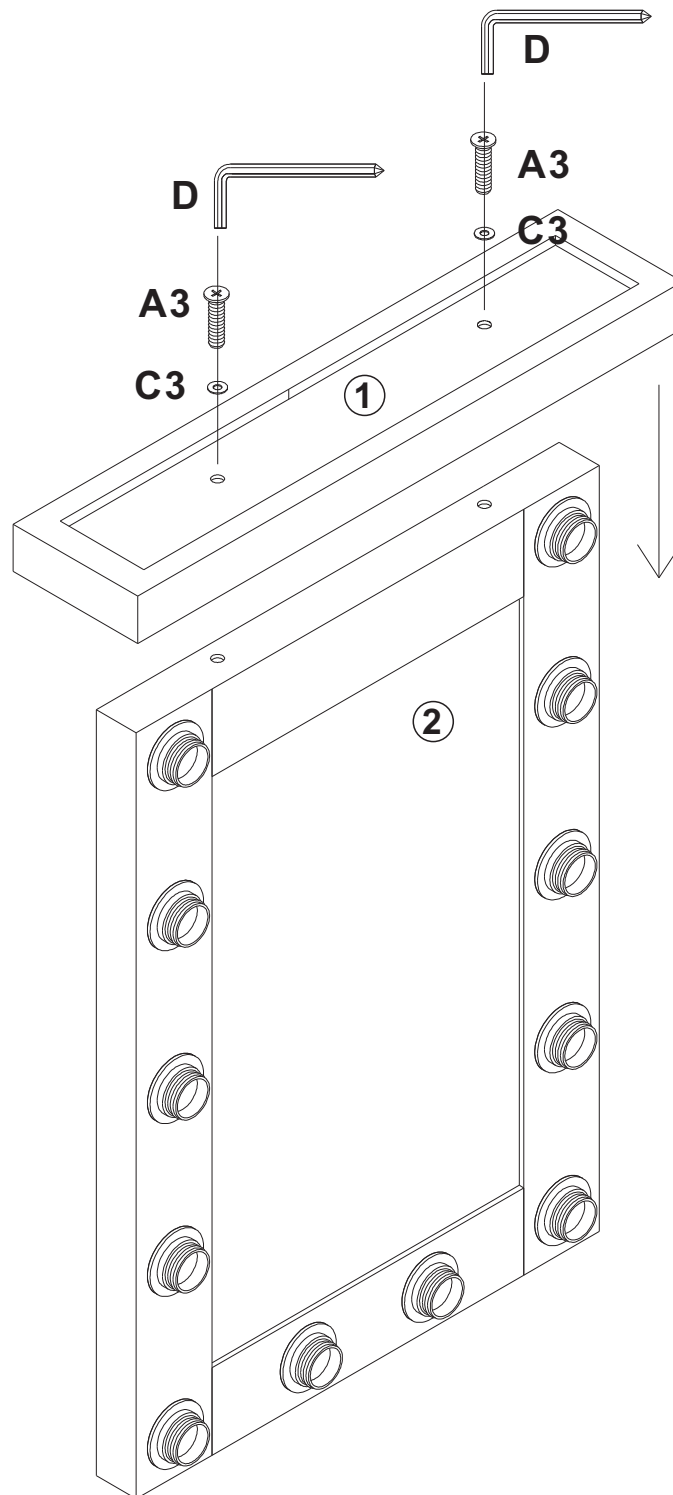

There maybe a slight odour from the adhesive on the product when unboxing.  
This will pass after a number of days of being unpackaged.

## Top Tips before you start !

1. Please check that all parts are present before you start the assembly of your furniture, as once assembled, the furniture is exempt from our home approval policy.
2. For ease and speed of assembly, we recommend that before you commence each step of the assembly, that you identify all the parts required for that step.
3. For larger items, please ensure that you have sufficient space and people (as indicated on page 1) to assemble your product safely.
4. We recommend that, where possible, all items are assembled near to the area in which they will be placed in use, to avoid moving the product unnecessarily once assembled.
5. For the protection of your furniture, particularly items of high gloss finish, we recommend that the product is placed on a protected surface during assembly to prevent any damage.
6. During assembly please take care not to over-tighten any fittings, as this may damage the product.

## Care and Maintenance of your furniture.

- Please periodically check all fittings and re-tighten as necessary.
- Please do not drag or pull your furniture.
- Wipe occasionally with a soft cloth slightly dampened with water, then buff with a dry clean soft cloth.
- Never allow any kind of liquid to remain on your furniture. Absorption can cause wood to warp or finishes to de-laminate.
- Please do not place hot item (e.g. hot drinks) directly on to the wood surface.
- If the glass is chipped or broken, stop using the product and consult the supplier.
- Please do not place very hot or very cold items on the glass surface, unless adequately thick table mats are used to prevent such items from coming into contact with the glass.
- Please do not use glass as chopping surface. Do not strike the glass with hard or pointed items.
- When cleaning glass panels use a damp cloth with washing up liquid or soft soap if necessary. Do not use washing powders or any other substances containing abrasives since these substances scratch glass panel.